



TPD-BC3G-26 Range

8 bands - 700MHz LTE, Quadband cellular, 3G UMTS / AWS, GPS, LTE / WIMAX 2.6GHz

Suitable for bundling with datacards and USB modems
CRC9, SMA or TS9 Connector

The TPD-BC3G-26 range antenna is a range of highly efficient and portable data card antenna. These paddle style antennas are easily positioned on a notebook or laptop screen using a hook and loop pad and the connector is plugged directly into the mobile broadband data card, express card or USB modem.

These antennas have been designed to fit in the packaging that the modems are sold in, making them perfect for bundling as an accessory to improve customer data and retention rates.

Technical Drawing

TPD-BADEP3G-26-05SMA Show

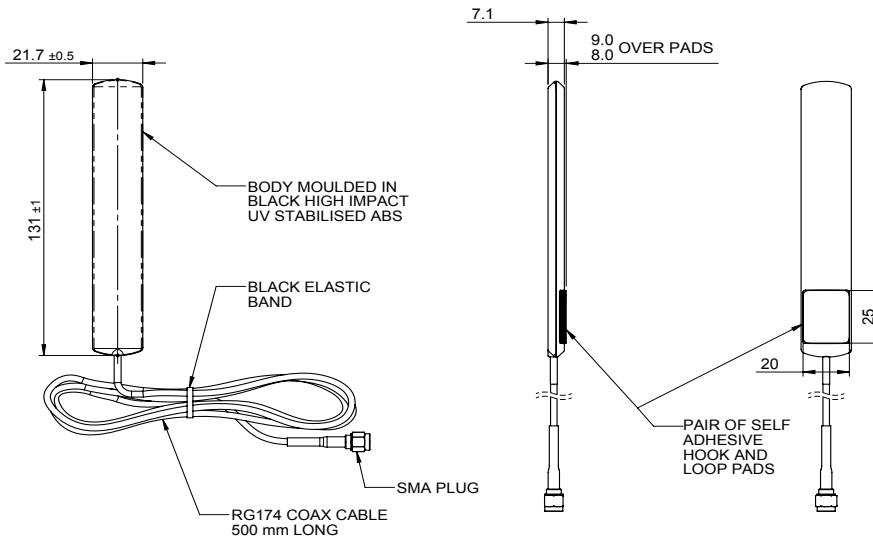

Panorama Antennas Ltd

Frogmore, London, SW18 1HF, United Kingdom

T: +44 (0)20 8877 4444

F: +44 (0)20 8877 4477

E: sales@panorama-antennas.com

www.panorama-antennas.com

Waiver: The data given above is indicative of the performance of the product/s under particular conditions and does not imply a guarantee of performance. These specifications are subject to change without notice. Copyright © Panorama Antennas Ltd. All rights reserved.

Mobile Broadband

2G/3G/4G Modem Paddle Antenna

3D Plot (700 MHz)

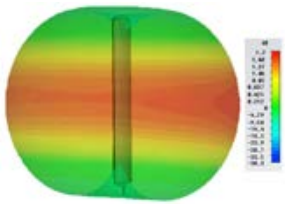

3D Plot (850MHz)

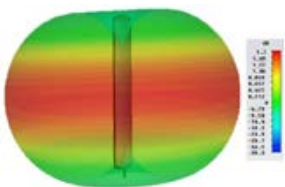

3D Plot (900MHz)

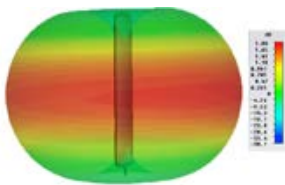

3D Plot (1800MHz)

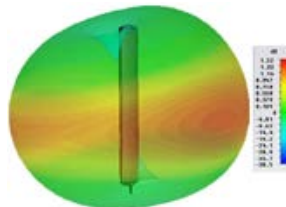

3D Plot (1900/2100 MHz)

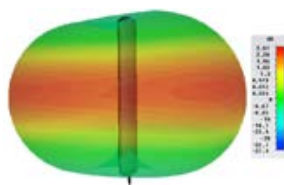

3D Plot (2600MHz)

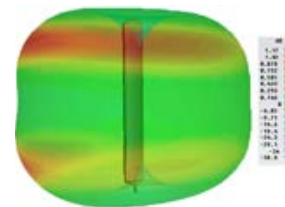

Typical VSWR*

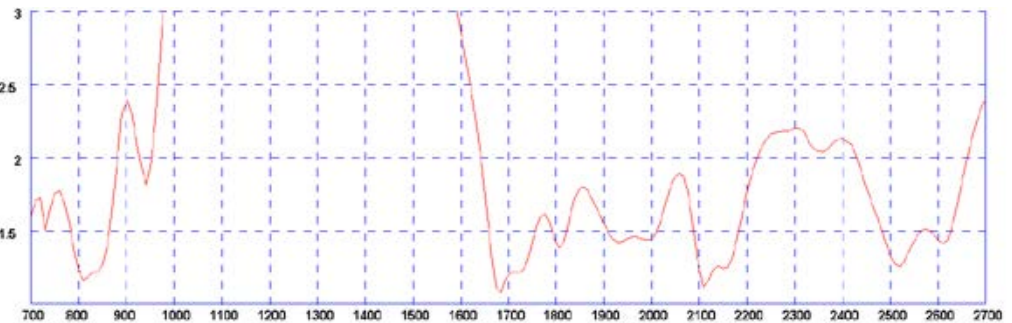

* VSWR measured with 0.5m (1.5') of RG174 Cable

Part No.

TPD-BC3G-26-05TS9

TPD-BC3G-26-05CRC9

TPD-BC3G-26-05SMAP

Electrical Data

Frequency Range (MHz)	698-960, 1575, 1710-2170, 2396-2700	698-960, 1575, 1710-2170, 2396-2700	698-960, 1575, 1710-2170, 2396-2700
Operational Band	LTE 700, GSM850 / CDMA850, GSM900, GSM1800, PCS1900, 3G UMTS, AWS, LTE/ WIMAX2600 & GPS	LTE 700, GSM850 / CDMA850, GSM900, GSM1800, PCS1900, 3G UMTS, AWS, LTE/ WIMAX2600 & GPS	LTE 700, GSM850 / CDMA850, GSM900, GSM1800, PCS1900, 3G UMTS, AWS, LTE/ WIMAX2600 & GPS
Typical VSWR	<2.5:1	<2.5:1	<2.5:1
Peak Gain: Isotropic	2dBi	2dBi	2dBi
Compared to ¼ wave	0dB	0dB	0dB
Polarisation	Vertical	Vertical	Vertical
Pattern	Omni-directional	Omni-directional	Omni-directional
Impedance	50Ω	50Ω	50Ω
Max Input Power (W)	10	10	10

Mechanical Data

Dimensions (mm)	Length	131 (5.16")	131 (5.16")	131 (5.16")
	Width	20 (0.79")	20 (0.79")	20 (0.79")
	Thickness	7(0.27")	7(0.27")	7(0.27")
Material	Black ABS			
Operating Temp (°C)	-40°/ 176°F (-40° / +80°C)			
Approx Weight (g)	19			

Mounting Data

Type	Adhesive hook & loop pad	Adhesive hook and loop pad	Adhesive hook and loop pad
------	--------------------------	----------------------------	----------------------------

Cable Data

Type	RG174	RG174	RG174
Diameter (mm)	2.6 (0.10")	2.6 (0.10")	2.6 (0.10")
Length (m)	0.5 (19.7")	0.5 (19.7")	0.5 (19.7")
Termination	TS9 plug	CRC9 Plug	SMA Plug