

# 4x MiMo 4G/5G Antenna

## DWMM4[G]-6-60



- 4x4 MiMo 4G/5G antenna solution
- Wall, mast or desk mount
- Optional GPS/GNSS - 26dB LNA
- Integrated coaxial cables

The DWMM4[G]-6-60 antenna provides 4x4 MiMo solution for global 4G/5G networks from 617-6000MHz. Incorporating four separately fed ultra wideband elements in a single housing the DWMM4[G] is suitable for a huge range of fixed site and failover applications.

The supplied mounting bracket enables simple wall mounting using the supplied screws and wall plugs and mast mounting using the supplied clamps. The antenna can also be mounted with screws directly to non-conductive panels or internal walls or stood on a desk using supplied mounting feet.

The omni-directional radiation pattern allows easy placement of the antenna without requiring directional alignment.

The DWMM4G type is supplied with an integrated GPS/GNSS module with 26dB LNA gain and advanced filtering to combat noise.

The antenna is fitted with integrated flame retardant CS32 cable (FR CS29 for GPS/GNSS) which minimises exposed connector joints and simplifies cable management for easy installation.

### Technical Drawing

DWMM4G-6-60-5SP Shown

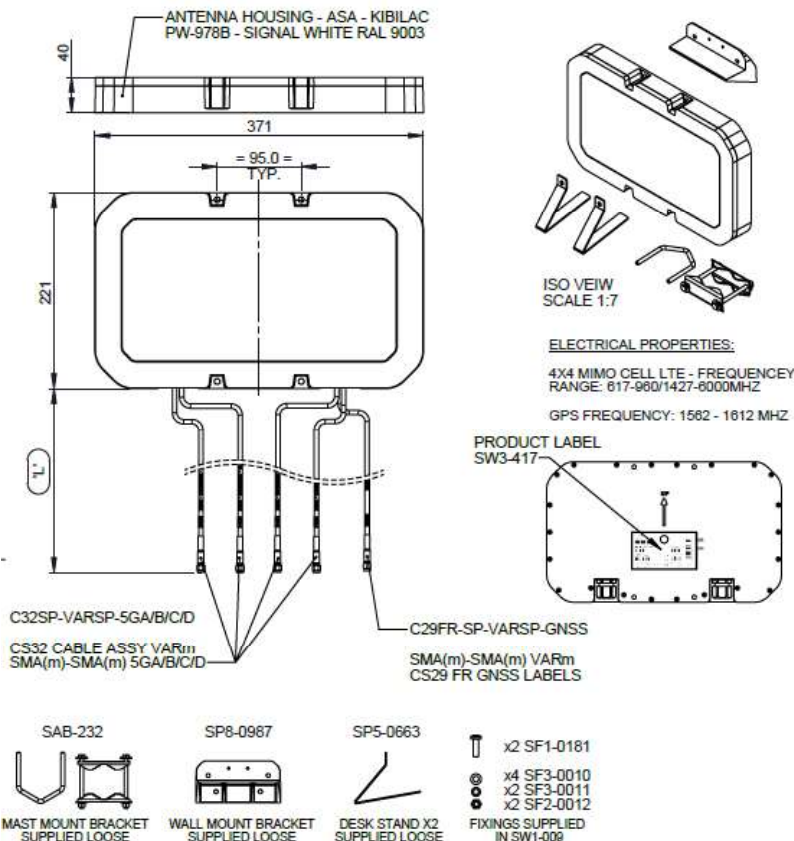

# 4x MiMo 4G/5G Antenna

## DWMM4[G]-6-60

### Product Data

Part No.		DWMM4G-6-60-5SP	DWMM4G-6-60-5FKJ	DWMM4G-6-60-5NP	DWMM4G-6-60-05NJ
<b>Electrical Data</b>					
Frequency Range (MHz)	Elements 1-4	617-960 / 1427-6000			
	Element 5	1559-1612			
Operational Band	Elements 1-4	2G/3G/4G/5G			
	Element 5	GPS/GNSS			
Peak Realised Gain: Isotropic* Elements 1-4	617-960MHz	3.5dBi			
	1427-2700MHz	5dBi			
	3400-4200MHz	6dBi			
	4900-6000MHz	7dBi			
Typical VSWR**		<2.5:1			
Nominal Radiated Efficiency*		> 70%			
Correlation Co-efficient		< 0.1			
Polarisation		+/-45 degrees			
Pattern		Hybrid			
Impedance		50Ω			
Max Input Power (W)		10			
<b>GPS/GNSS Data</b>					
Frequency Range (MHz)		1559-1612			
Typical VSWR		<2.5:1			
LNA Gain		26dB (+/-3)			
Polarisation		RHCP			
Operating Voltage		3-5 VDC <20ma			
<b>Mechanical Data</b>					
Dimensions (mm)	Length	371 (14.6")			
	Height Excl Brkt	221 (8.7")			
	Depth	40 (1.57")			
Operating Temp (°C)		-40° / +85°C ( -40° / 185°F )			
Radome Material		ASA			
Material Approvals		Radome ASA Material - UL 746C F1, UL 94-HB			
Colour		White			
Ingress Protection		IP66			
<b>Mounting Data</b>					
Fixing		Wall, Mast, Rail or Panel Mount			
Max Mast Diameter (mm)		50 (1.96")			
<b>Cable Data</b>					
4G/5G Cables	Type	CS32 (EN45545-2 Compliant)			
	Diameter (mm)	5 (0.19")			
	Length (m)	5 (16' 4")	5 (16' 4")	5 (16' 4")	0.5 (1' 6")
	Termination	SMA (m)	FAKRA D Jack	N (m)	N(f)
GPS/GNSS Cables	Type	CS29 FR (EN45545-2 & UN ECE R118 Compliant)			
	Diameter (mm)	5 (0.19")			
	Length (m)	5 (16' 4")	5 (16' 4")	5 (16' 4")	0.5 (1' 6")
	Termination	SMA (m)	FAKRA C Jack	N (m)	N(f)

\* Peak gain and efficiency simulated in CST microwave studio for each element in free space excluding cable loss \*\* Typical VSWR measured with 0.5m (1.5') of cable in free space.

# 4x MiMo 4G/5G Antenna

## DWMM4[G]-6-60

Part No.		DWMM4-6-60-5SP	DWMM4-6-60-5FKJ	DWMM4-6-60-5NP	DWMM4-6-60-05NJ
<b>Electrical Data</b>					
Frequency Range (MHz)	Elements 1-4	617-960 / 1427-6000			
Operational Band	Elements 1-4	2G/3G/4G/5G			
Peak Realised Gain: Isotropic* Elements 1-4	617-960MHz	3.5dBi			
	1427-2700MHz	5dBi			
	3400-4200MHz	6dBi			
	4900-6000MHz	7dBi			
Typical VSWR**	<2.5:1				
Nominal Radiated Efficiency*	> 70%				
Correlation Co-efficient	< 0.1				
Polarisation	+/-45 degrees				
Pattern	Hybrid				
Impedance	50Ω				
Max Input Power (W)	10				
<b>Mechanical Data</b>					
Dimensions (mm)	Length	371 (14.6")			
	Height Excl Brkt	221 (8.7")			
	Depth	40 (1.57")			
Operating Temp (°C)	-40° / +85°C ( -40° / 185°F )				
Radome Material	ASA				
Material Approvals	Radome ASA Material - UL 746C F1, UL 94-HB				
Colour	White				
Ingress Protection	IP66				
<b>Mounting Data</b>					
Fixing	Wall, Mast, Rail or Panel Mount				
Max Mast / Rail Diameter (mm)	50 (1.96")				
<b>Cable Data</b>					
4G/5G Cables	Type	CS32 (EN45545-2 & UN ECE R118 Compliant)			
	Diameter (mm)	5 (0.19")			
	Length (m)	5 (16' 4")	5 (16' 4")	5 (16' 4")	0.5 (1' 6")
	Termination	SMA (m)	FAKRA D Jack	N (m)	N(f)

b

\* Peak gain and efficiency simulated in CST microwave studio for each element in free space excluding cable loss \*\* Typical VSWR measured with 0.5m (1.5') of cable in free space.

# 4x MiMo 4G/5G Antenna

## DWMM4[G]-6-60

### Electrical Data

Typical VSWR\*

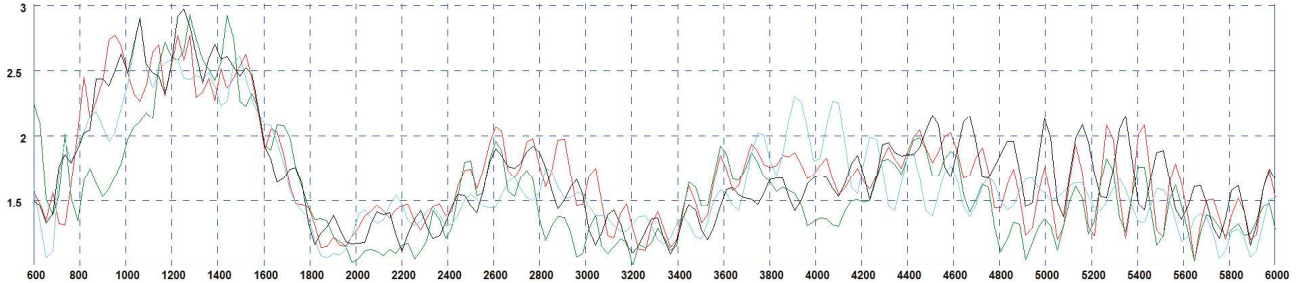

\*Typical VSWR for elements 1-4 measured in free space with 0.5m (1.5') of CS32 cable.

Typical Isolation\*



\*Red Plot = Worst case isolation - element B to element C 0.5m (1.5') of cable Green Plot = Best case isolation - element A to element B- 0.5m (1.5') of cable

Typical Efficiency\*

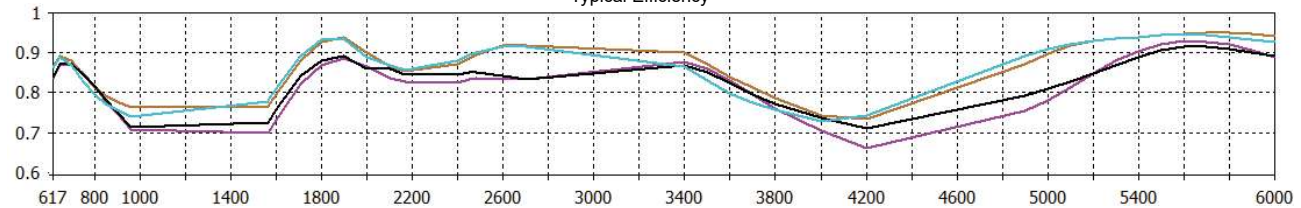

\*Typical efficiency simulated in CST Microwave Studio in free space without cable.

Typical Swept Peak Gain\*

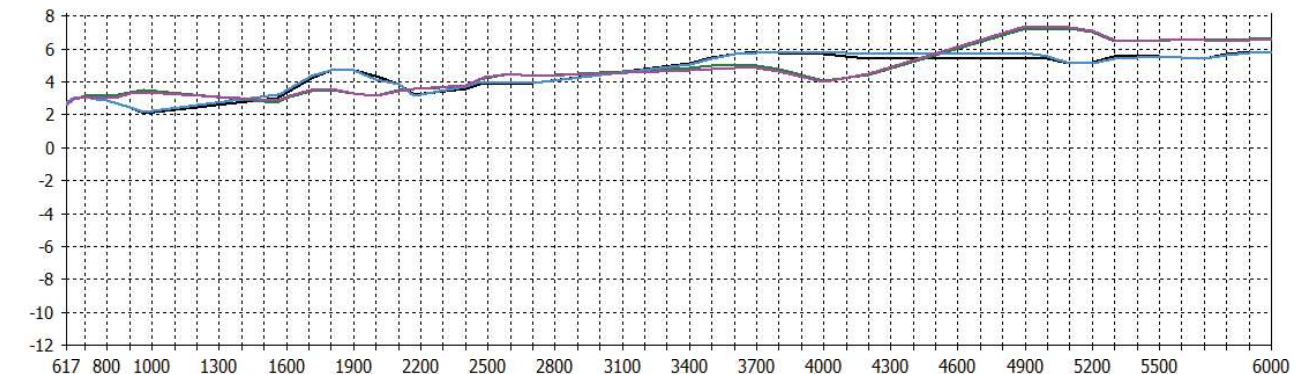

\* Peak gain simulated in CST Microwave Studio in free space without cable.

### 3D Patterns - 4G/5G Side

3D Plot Element A Side (650 MHz)

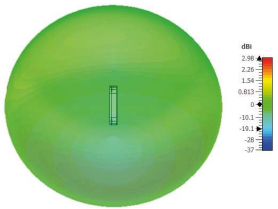

3D Plot Element B Side (650 MHz)

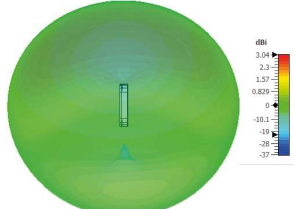

3D Plot Element C Side (650 MHz)

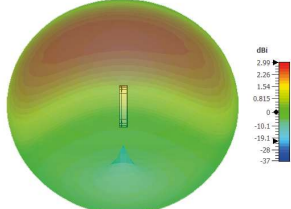

3D Plot Element D Side (650 MHz)

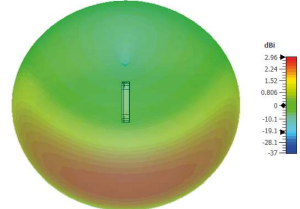

3D Plot Element A Side (750 MHz)

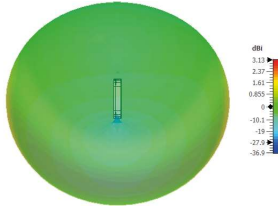

3D Plot Element B Side (750 MHz)

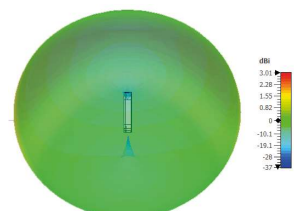

3D Plot Element C Side (750 MHz)

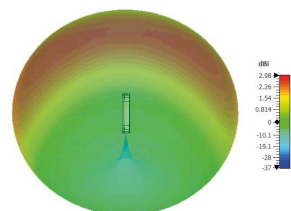

3D Plot Element D Side (750 MHz)

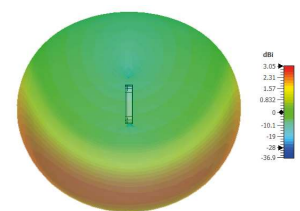

3D Plot Element A Side (850 MHz)

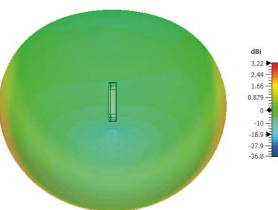

3D Plot Element B Side (850 MHz)

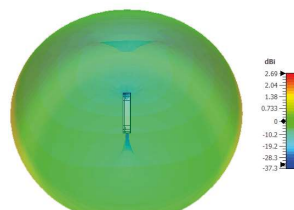

3D Plot Element C Side (850 MHz)

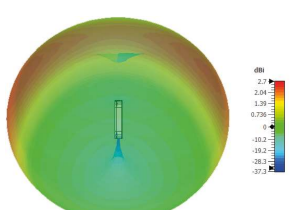

3D Plot Element D Side (850 MHz)

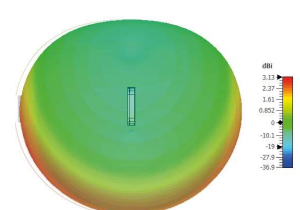

3D Plot Element A Side (1800 MHz)

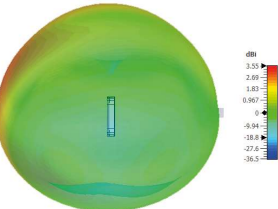

3D Plot Element B Side (1800 MHz)

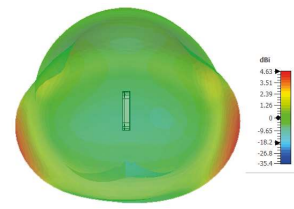

3D Plot Element C Side (1800 MHz)

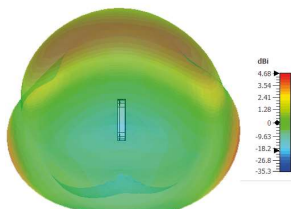

3D Plot Element D Side (1800 MHz)

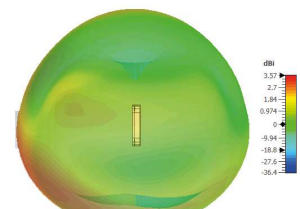

3D Plot Element A Side (2000MHz)

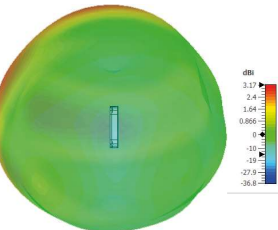

3D Plot Element B Side (2000 MHz)

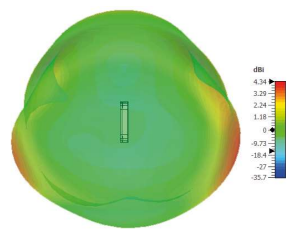

3D Plot Element C Side (2000 MHz)

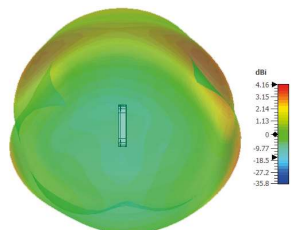

3D Plot Element D Side (2000 MHz)

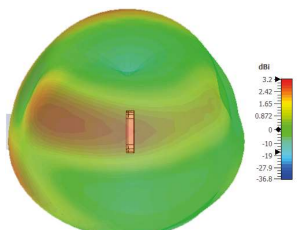

3D Plot Element A Side (2600MHz)

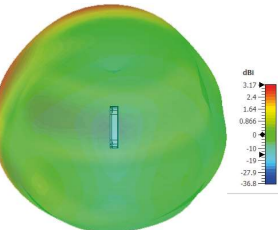

3D Plot Element B Side (2600 MHz)

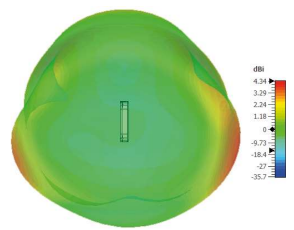

3D Plot Element C Side (2600 MHz)

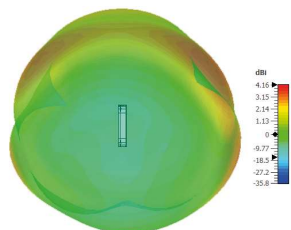

3D Plot Element D Side (2600 MHz)

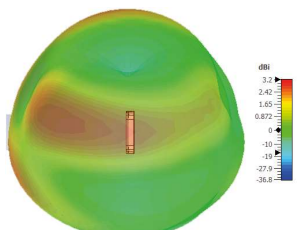

\* 3D patterns simulated for each element in CST microwave studio in free space excluding cable loss

3D Patterns - 4G/5G Side

3D Plot Element A Side (3600MHz)

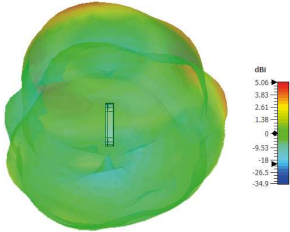

3D Plot Element B Side (3600 MHz)

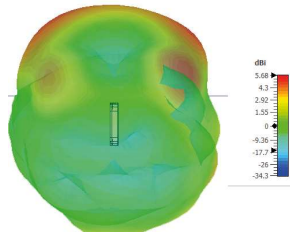

3D Plot Element C Side (3600 MHz)

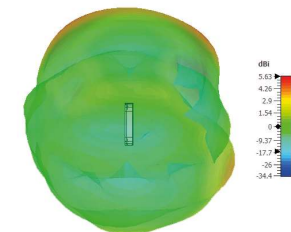

3D Plot Element D Side (3600 MHz)

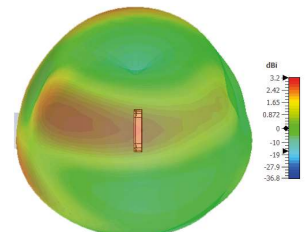

3D Plot Element A Side (5400MHz)

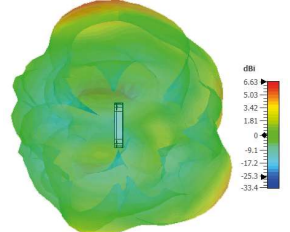

3D Plot Element B Side (5400 MHz)

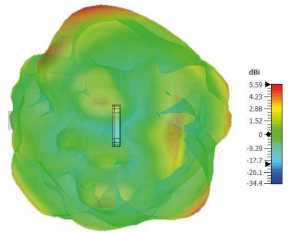

3D Plot Element C Side (5400 MHz)

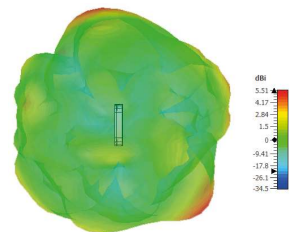

3D Plot Element D Side (5400 MHz)

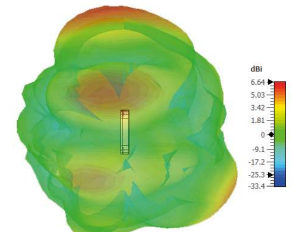

\* 3D patterns simulated for each element in CST microwave studio in free space excluding cable loss

### 3D Patterns - 4G/5G Top

3D Plot Element A Top (650 MHz)

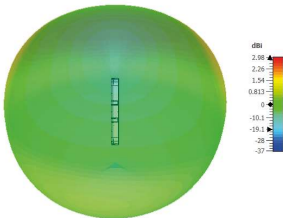

3D Plot Element B Top (650 MHz)

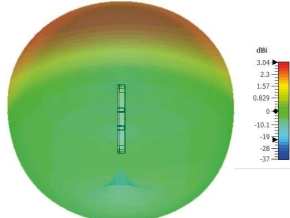

3D Plot Element C Top (650 MHz)

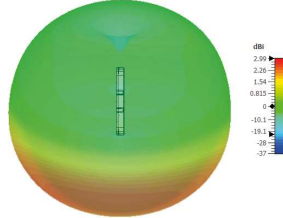

3D Plot Element D Top (650 MHz)

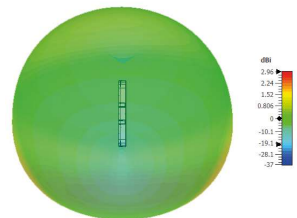

3D Plot Element A Top (750 MHz)

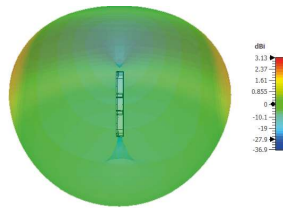

3D Plot Element B Top (750 MHz)

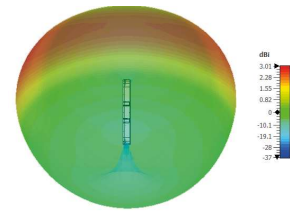

3D Plot Element C Top (750 MHz)

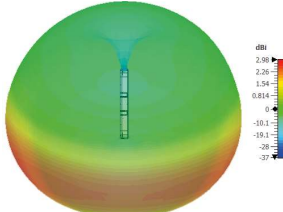

3D Plot Element D Top (750 MHz)

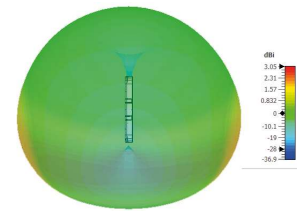

3D Plot Element A Top (850 MHz)

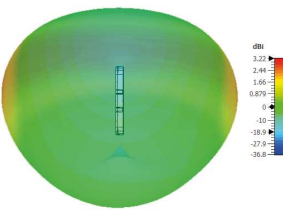

3D Plot Element B Top (850 MHz)

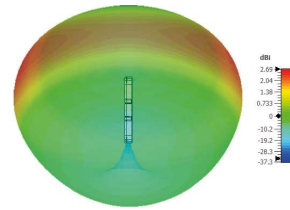

3D Plot Element C Top (850 MHz)

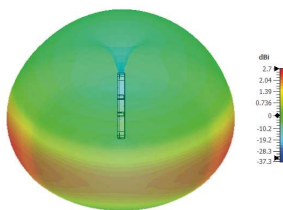

3D Plot Element D Top (850 MHz)

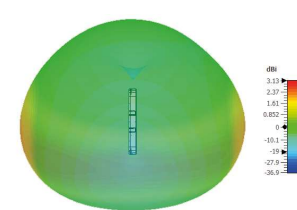

3D Plot Element A Top (1800 MHz)

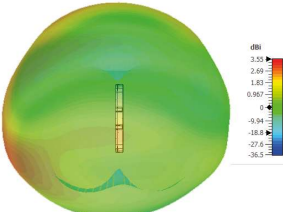

3D Plot Element B Top (1800 MHz)

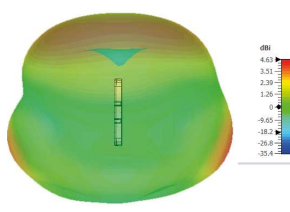

3D Plot Element C Top (1800 MHz)

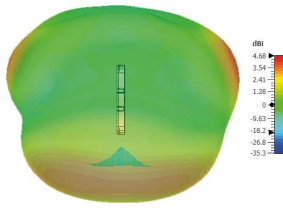

3D Plot Element D Top (1800 MHz)

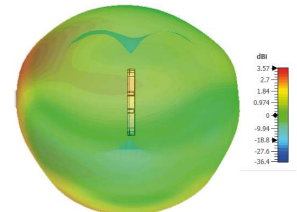

3D Plot Element A Side (2000MHz)

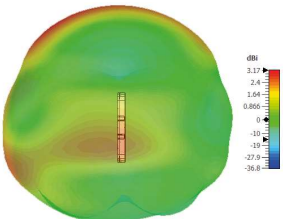

3D Plot Element B Side (2000 MHz)

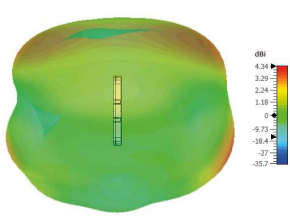

3D Plot Element C Side (2000 MHz)

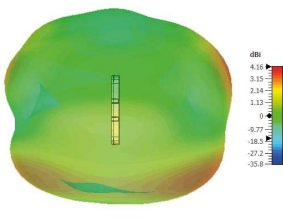

3D Plot Element D Side (2000 MHz)

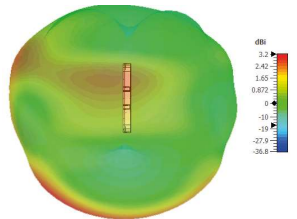

3D Plot Element A Top (2600MHz)

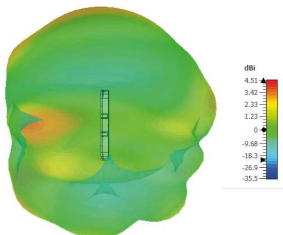

3D Plot Element B Top (2600 MHz)

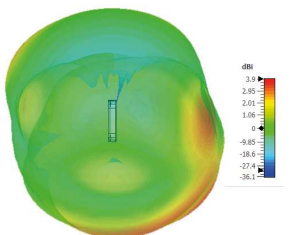

3D Plot Element C Top (2600 MHz)

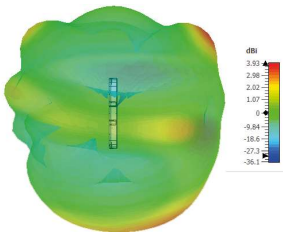

3D Plot Element D Top (2600 MHz)

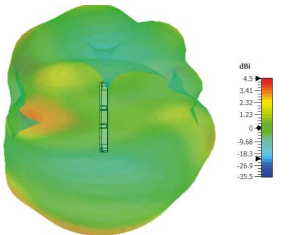

\* 3D patterns simulated for each element in CST microwave studio in free space excluding cable loss

3D Patterns - 4G/5G  
Top

3D Plot Element A Top (3600MHz)

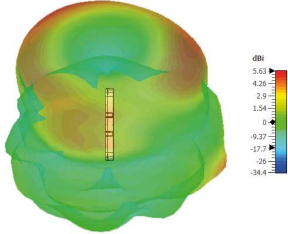

3D Plot Element B Top (3600 MHz)

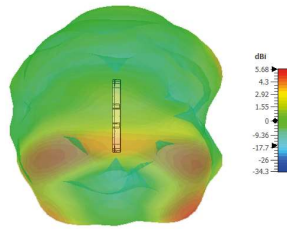

3D Plot Element C Top (3600 MHz)

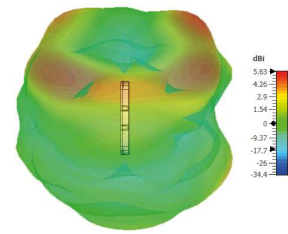

3D Plot Element D Top (3600 MHz)

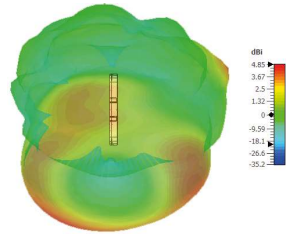

3D Plot Element A Top (5400MHz)

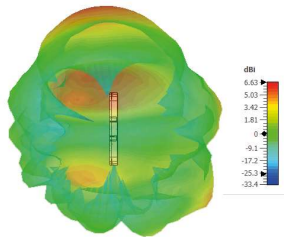

3D Plot Element B Top (5400 MHz)

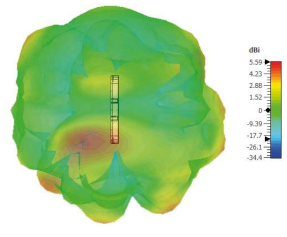

3D Plot Element C Top (5400 MHz)

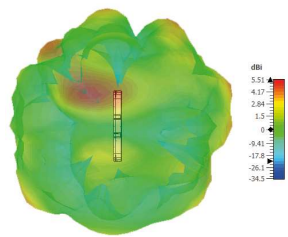

3D Plot Element D Top (5400 MHz)

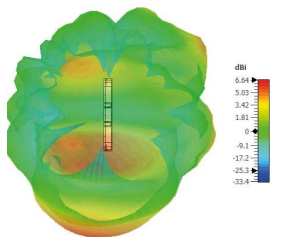

\* 3D patterns simulated for each element in CST microwave studio in free space excluding cable loss